



PROJECT		REF		REV	ITEM CODE	
LOCATION		DATE			PAGE	

SANITARY WARE SPECIFICATION SHEET

Item Descriptions	Stern (Israel) "Wave sensor" Concealed touch free wave shower sensor in AC Supply with 5m wire AC 110-240 Vac 50/60Hz to 9V 0.3A IP68 waterproof switching transformers	Illustration/ Drawing
Dimensions	L57 x W35 x H35 mm	
Model	Wave kit for shower	
Coda Number	620810	
Finish	Chrome Plated	
Source	Acme Sanitary Ware Co. Ltd Mr. Eric Wong / Mr. Don Yuen	
Contact Tel/Fax	(852) 2388-7171 / (852) 2710-8012	
E-mail	acme@acmesanitary.com.hk	
Website	www.acmesanitary.com.hk	

WAVE ON-OFF SENSOR KIT FOR SHOWER Ref # 620810

Touch free electronic wave on-off sensor kit for showers. Includes a wave on-off sensor unit, solenoid valve with housing and power supply. Filter included. The following settings can be changed by using the Stern remote control: Sensor Range, Delay In, Delay Out and On-Off.

Application:

Allows quick and easy modification of almost any traditional sanitary ware into an automatic touch-free one. Being modular, it fits any interior and can be integrated with any existing water outlet.

Use:

Touch free electronic wave on-off sensor kit for shower. The shower is activated automatically when the user enters the sensor range and stops when the user leaves the sensor range.

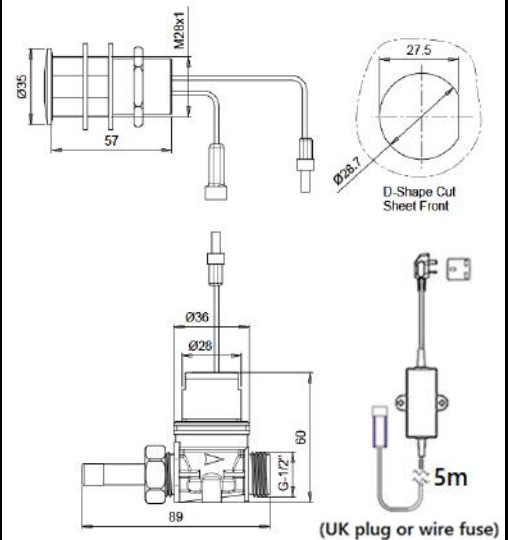

- Water supply:**
Cold or premixed water (1 inlet)
- Water temperature:**
Max 70°C
- Operating pressure:**
0.5 - 8.0 bar
- Power source:**
IP68 Encapsulated transformer



* All information of the above is for the reference only. No prior notice is made if any changes.



SANITARY WARE SPECIFICATION SHEET

PROX, WAVE & TOUCH SOLUTIONS

TOUCH FREE & TOUCH OPERATED SHOWER UNITS

Operated by an IR sensor or a Piezo button. Can be integrated with a shower panel, shower control or as an individual unit. For cold or premixed water.

Advantages:

TOUCH FREE OPERATION:

- Drastically reduces water consumption
- No physical contact. Helps to protect users against cross contamination.
- Sensor settings adjustable by remote control

TOUCH OPERATION:

- Drastically reduces water consumption
- Non hold open feature
- More possibilities to save water: the water flow can be stopped in the middle of the cycle
- Stable and accurate water flow that can be changed on site



TOUCH FREE WAVE OPERATION

Allows activation of the shower once the users place their hands at a close proximity to the sensor.



Water will shut off if the users place their hands at a close proximity to the sensor again or once a factory set flow time of 120 seconds will pass. Flow time is adjustable by remote control.

TOUCH FREE PROX OPERATION

Allows automatic activation when the users bring their hands within the sensor range, and stops when the users remove their hands.

TOUCH OPERATION

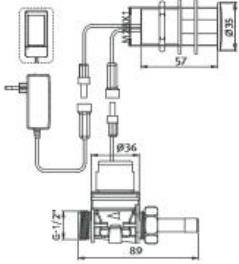
Allows activation of the shower / unit once the users touch the designated area in the Piezo button. Water will shut off if the users touch the designated area again or once a factory set flow time of 120 seconds will pass.

PICTURE	PRODUCT NAME	MODEL FEATURES	POWER SUPPLY	CODE NUMBER	DRAWING
	PROX KIT FOR SHOWER	<p>Concealed installation in dry or plaster wall. Option for front fixation installation in concrete, brick walls.</p> <p>Touch free Prox Operation Allows automatic activation when the users bring their hands within the sensor range, and stops when the users remove their hands.</p>	9V battery / 9V transformer	620000	
	WAVE KIT FOR SHOWER	<p>Concealed installation in dry or plaster wall. Option for front fixation installation in concrete, brick walls.</p> <p>Touch free Wave Operation Allows activation of the shower once the users place their hands at a close proximity to the sensor.</p> <p>Water will shut off if the users place their hands at a close proximity to the sensor again or once a factory set flow time of 120 seconds will pass. Flow time is adjustable by remote control.</p>	9V battery / 9V transformer	620810	

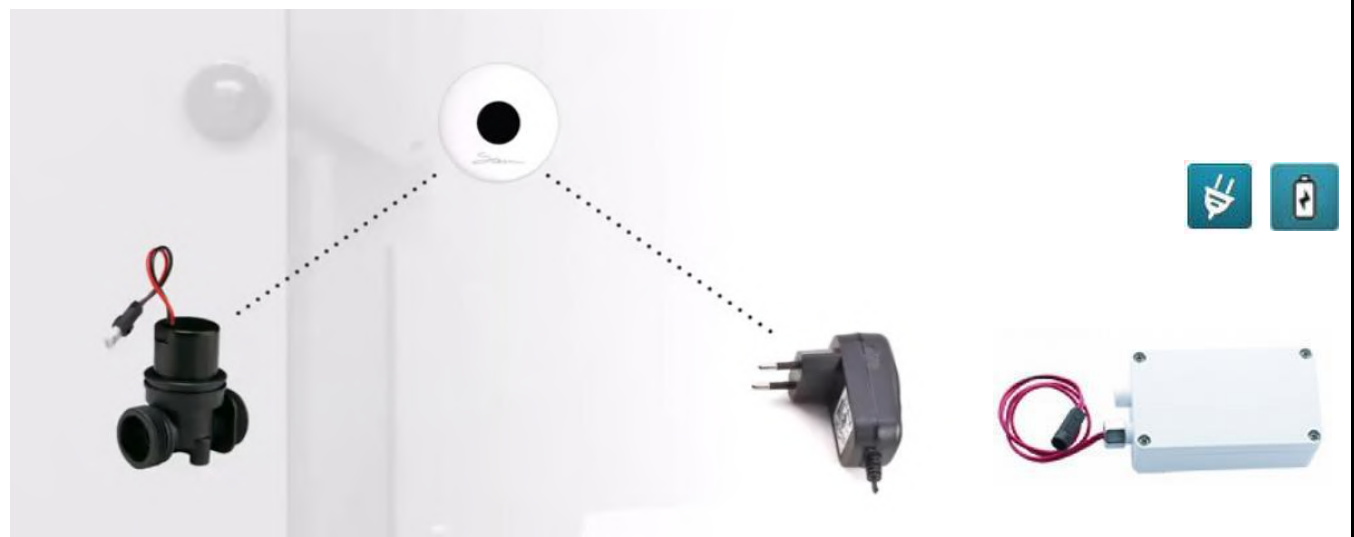

Note: In order to locate the relevant spare part, please check the corresponding parts and part number in the drawing. Minimum order quantity will be required.

* All information of the above is for the reference only. No prior notice is made if any changes.



INSTALLATION

WAVE ON-OFF

STEP 1 - PREPARATION FOR INSTALLATION

1 Remove the hexagonal nut, disk and gasket from the switch body.

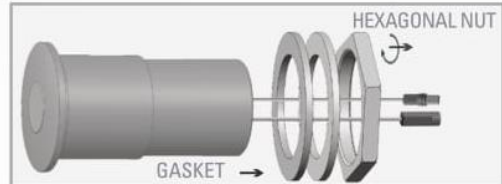

2 Shut off the water supply



STEP 2 – INSTALLING THE SYSTEM

1 Place the sensor at its designated location.

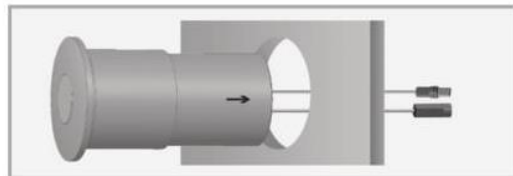

2 Slide the hexagonal nut, disk and gasket over the sensor body and secure them into place.

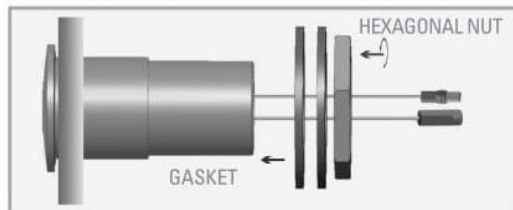

3 Connect the water outlet to the solenoid valve housing.



4 If your system is provided with an inlet nipple, fit the water supply inlet to the inlet nipple at the solenoid valve housing or connect it directly to the shut off valve.

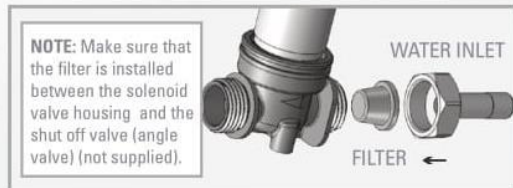



INSTALLATION

WAVE ON-OFF

5

Turn on the central water supply and the shut-off valves (angle valves) and check for leaks.

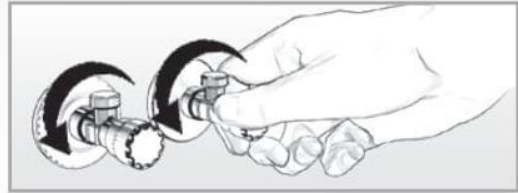

6

Connect the water proof connector coming from the wave sensor to the solenoid valve connector.

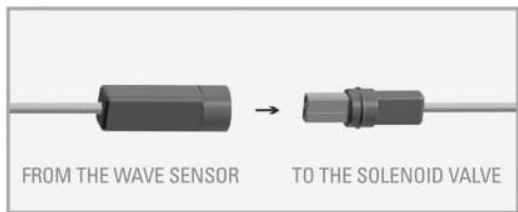

STEP 3 – CONNECTING THE POWER SOURCE

Connect the water proof connector coming from the wave sensor to the power source.

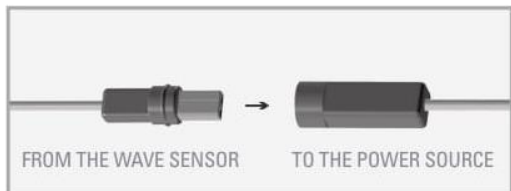

FOR BATTERY MODELS:

Install the battery box at the wall using the screws or the two sided adhesive foam tape.

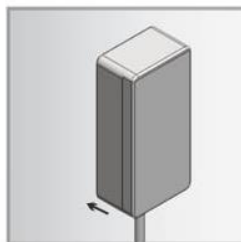

FOR TRANSFORMER MODELS:

- a. Connect the water proof connector coming from the wave sensor to the transformer.
- b. Plug the transformer into the electrical socket.

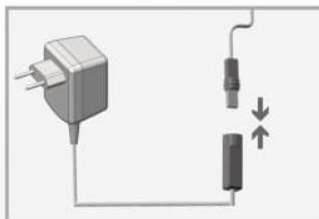

IMPORTANT: In order to avoid going into adjusting mode, wait 10 seconds before operating the system.